

Product data sheet

Item No. R:6587219196

Cross connector, insulated for DIN rail terminal blocks type WKF...,
4 -pole



Item No.	R:6587219196
EAN	
Order Unit	Piece(s)

Certificates / Approvals

Technical data

General

Type	Cross connector
Modular spacing	6 mm
Number of bridged clamps	4
Mounting method	Pluggable
Insulated	Yes

Accessories

Type	Cross connector
Mounting method	Pluggable
Insulated	Yes
Number of bridged clamps	4
Modular spacing	6 mm



Technical drawing

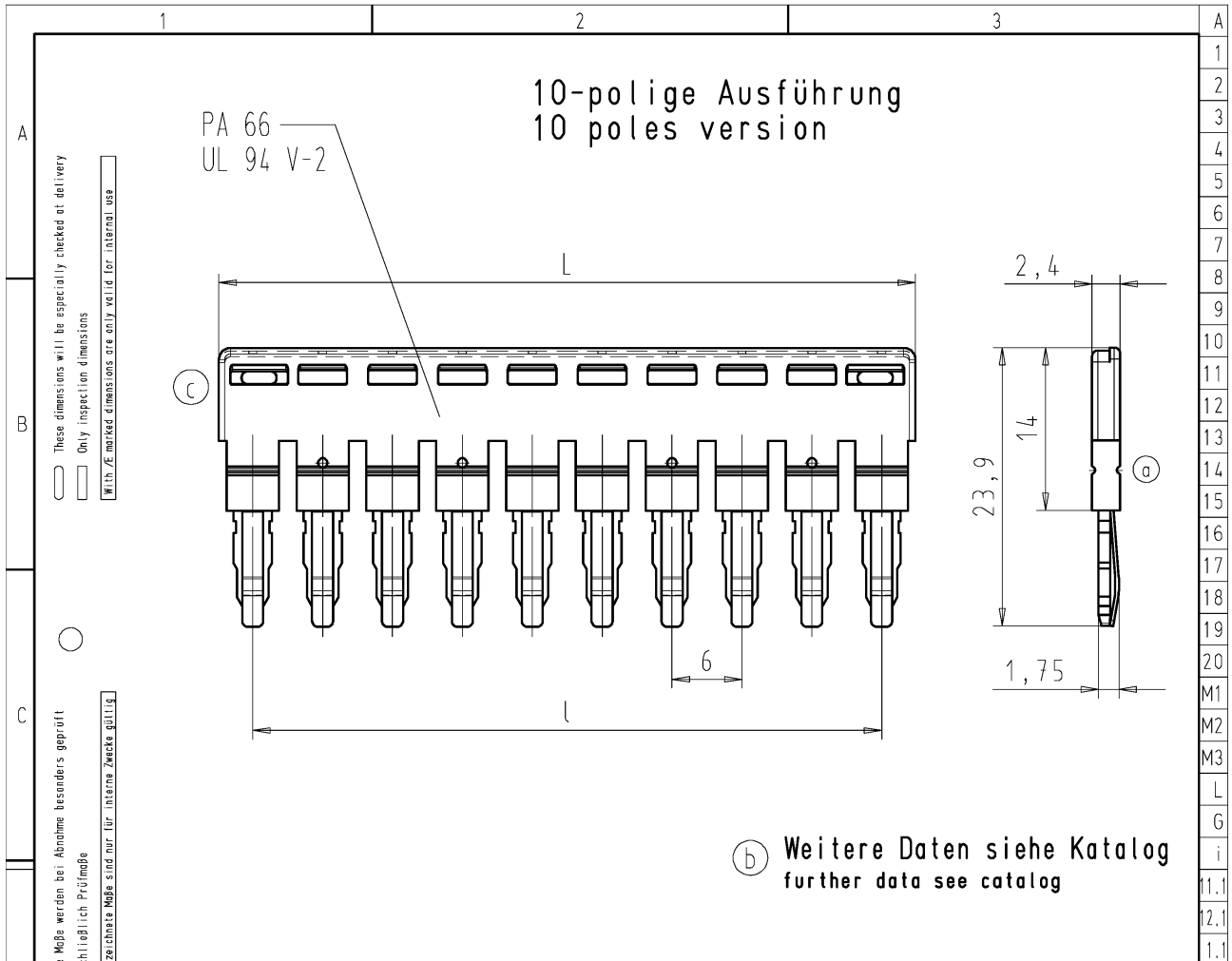

Teile-Nr. part nr.	Pol- zahl poles	L-0,2	l±0,05	Typ type
Z7.261.12MM.0	2			IVBWK 4 - 2
Z7.261.13MM.0	3	17,8	12	IVBWK 4 - 3
Z7.261.14MM.0	4	23,8	18	IVBWK 4 - 4
Z7.261.15MM.0	5	29,8	24	IVBWK 4 - 5
Z7.261.16MM.0	6	35,8	30	IVBWK 4 - 6
Z7.261.17MM.0	7	41,8	36	IVBWK 4 - 7
Z7.261.18MM.0	8	47,8	42	IVBWK 4 - 8
Z7.261.19MM.0	9	53,8	48	IVBWK 4 - 9
Z7.261.20MM.0	10	59,8	54	IVBWK 4 - 10

MM	
27	Katalogteil catalogue part
97	spezielle Verpackung special packing

Tolerierung Size ISO 14405/Tolerance system Size ISO 14405. ja/yes Stoffverbots- und Deklarationliste nach WM 5020.010 ist einzuhalten. Conformity with Wieland document WM 5020.010 e (list of prohibited / declarable hazardous substances) to be declared!

Freitoleranz nach General tolerance CAD - Zeichnung, keine manuellen Änderungen CAD - drawing, no manual modifications allowed 1.Verwendung: First Use: Blatt: 1 von 1 Sheet: 1 of 1

Werkstoff/Material	2001	Tag/Date	Name	Zeichnung Nr./Drawing No.	Index
	gezeichnet drawn	04.07.	TRESCHAN	Z7.261.1227.0 01K	c
	geprüft checked	-	-		
	Normgepr. Stand. check	-	-		

Maße in mm/Dimensions are in mm

c	15.12.2015/	Vol.	mm ³ Of l./Surf.	mm ²	Ersatz für/Replacement for:
b	24.01.2006/				
a	26.07.2005/				
Index	Datum / Blatt Date / Sheet				
Änderung/Revision					



Typ
IVB WK
4 - ..

VERBINDUNGSSTECKER
insulated jumper bar

